

Features

- 36-inch minimum base cabinet.
- Double equal bowls.
- 9-1/2-inch depth.
- Slim divide creates more space while allowing you to completely submerge pots and pans.
- No faucet holes.
- Rear drains increase workspace in the sink and storage space underneath.
- Includes K-5656 bottom sink rack.
- Includes cutout templates and installation clips.

Material

- KOHLER Neoroc® composite is durable and built to withstand day-to-day cleaning tasks.
- Matte finish offers rich, dimensional color.
- Solid color throughout the sink.
- Heat resistant up to 750 degrees F.
- Scratch, stain, chip, and thermal-shock resistant.

Installation

- Under-mount
- Easy to install in a one-person, single-day project.

Recommended Products/Accessories

K-9000 P-Trap
K-5656 Sink Rack
K-6377 Sponge Caddy
K-6378 Kitchen Brush Caddy
K-6379 Kitchen Squeegee
K-6382 Disinfecting Wipes Dispenser
K-6383 Soap Dispenser
K-8618 Paper Towel Holder
K-8619 Flexible Kitchen Mat
K-8624 Dish Scraper
K-8801 Sink Strainer
K-8799 Sink Strainer

Included Components

Product consists of:
K-5656 Sink Rack



Codes/Standards







CSA B45.5/IAPMO Z124

KOHLER® Neoroc® Sinks Lifetime Limited Warranty

See website for detailed warranty information.

Available Colors/Finishes

Color tiles intended for reference only.

Color	Code	Description
	CM6	Matte White
	CM7	Matte Graphite
	CM5	Matte Beige
	CM1	Matte Black
	CM2	Matte Brown
	CM3	Matte Toupe
	CM4	Matte Grey

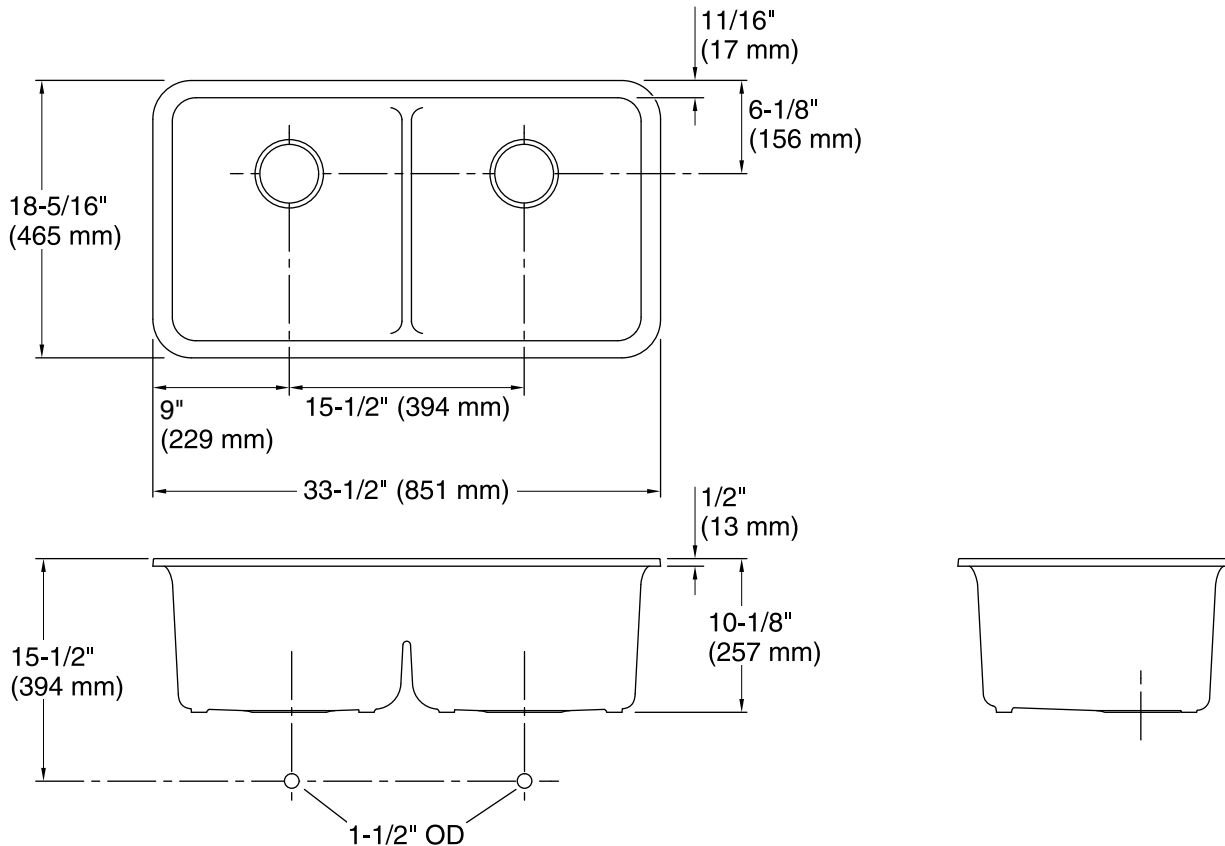

Technical Information

All product dimensions are nominal.

Bowl configuration:	Double equal
Installation:	Under-mount
Min. base cabinet width:	36" (914 mm)
Bowl area (Left):	Length: 14-7/8" (378 mm) Width: 15-3/16" (386 mm) Bowl depth: 9-1/2" (241 mm) Water depth: 9-1/2" (241 mm)
Bowl area (Right):	Length: 14-7/8" (378 mm) Width: 15-3/16" (386 mm) Bowl depth: 9-1/2" (241 mm) Water depth: 9-1/2" (241 mm)
Drain hole:	3-7/8" (98 mm)
Template:	1256394-7, required, included

Notes

Install this product according to the installation instructions.