



# McAllister®

## Under-Mount Kitchen Sink

### 11600

#### Features

- Under-mount
- No faucet holes to accommodate either wall-mount or countertop faucets
- 9-5/16"-deep single bowl
- 3-5/8" rear drain opening
- Stainless steel with a luster finish
- SilentShield technology
- 18-gauge stainless steel
- Lifetime limited warranty

#### Recommended Products/Accessories

7400 Sink Strainer  
11867 Sink Rack

#### Included Components

Product consists of:  
91915 Hardware Kit



#### Codes/Standards

ASME A112.19.3/CSA B45.4

#### STERLING® Warranty - Stainless Steel Sinks

See website for detailed warranty information.

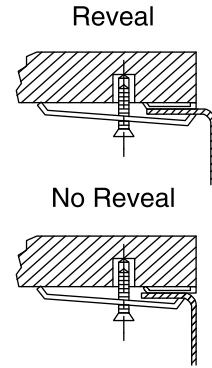
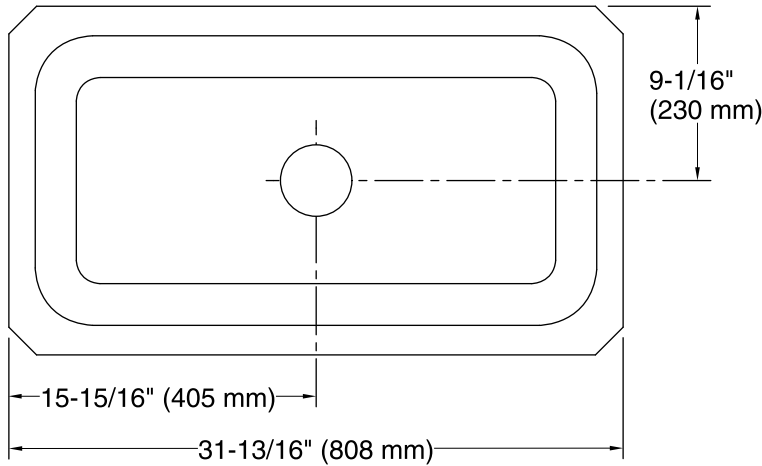

**Mounting bracket assembly provides a secure installation.**

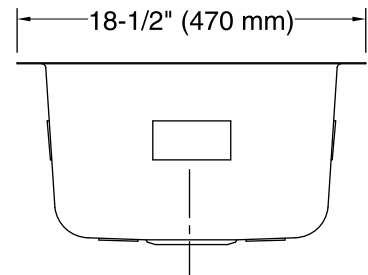
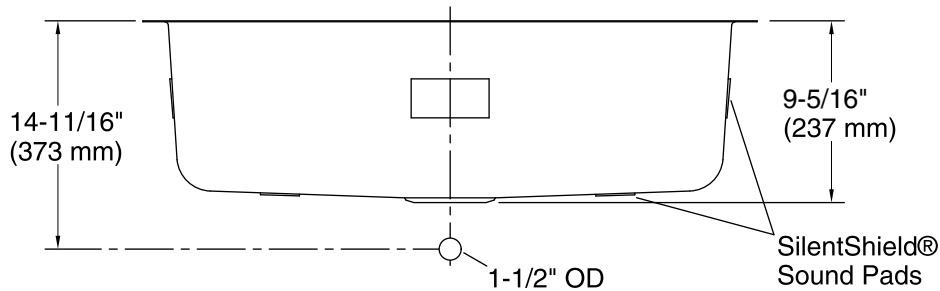

**Technical Information**

All product dimensions are nominal.

Bowl configuration: Single

Installation: Under-mount

Min. base cabinet width: 36" (914 mm)

Bowl area (Only): Length: 29-1/2" (749 mm)  
Width: 15-3/4" (400 mm)  
Bowl depth: 9" (229 mm)  
Water depth: 9" (229 mm)

Drain hole: 3-5/8" (92 mm)

Template: 1062109-7, required, included

**Notes**

Install this product according to the installation instructions.

Measure your actual product for roughing-in details.

Use the supplied cut-out template to select either a hidden or exposed rim.

Minimum base cabinet width: 33"-36" (33" cabinet may require cabinet modifications). Consult an installer for confirmation before proceeding.